

NOTES

- 1) ALL DIMENSIONS GIVEN IN INCHES UNLESS OTHERWISE SPECIFIED.
- 2) DESIGN CONDITIONS:
 MAX PRESSURE 150 PSI
 MAX TEMPERATURE 140°F
 1006 GPM @ 70' TDH
- 3) APPROXIMATE MASS: 1519 LBS (DRY)

#	COMPONENT
1	NEMA 4X, UL, 460V/3PH/60Hz CONTROL PANEL, FLA=33.7A
2	FILTER: 8" EBS-10000, 50 MICRON SCREEN
3	PUMP: 30HP 3600RPM, 460/3/60, 1006 GPM @ 70' TDH
4	PURGE: 3" BERMAID 400 SERIES
5	BASE: EPOXY COATED CARBON STEEL
6	FACE PIPE: 8" 304SS
7	SOLENOID: 24VAC ASCO RED HAT
8	PD SWITCH: MIDWEST MODEL 146
9	DRIVE MOTOR: 1/2HP BALDOR IP55
10	ISOLATION VALVES: 8" BRAY SERIES 31 BUTTERFLY VALVE

Amiad WATER SYSTEMS
 120-J TALBERT ROAD
 MOORESVILLE, NC 28117
 PH: (704) 662-3133
 FAX: (704) 662-3155

THIS DRAWING, AND THE INFORMATION CONTAINED HEREIN, IS THE PROPERTY OF AMIAD WATER SYSTEMS. ANY USE OR REPRODUCTION THEREOF WITHOUT THE WRITTEN PERMISSION OF AMIAD WATER SYSTEMS ENGINEERING DEPARTMENT IS STRICTLY PROHIBITED.	
DRAWING DATE: 7/29/2016	DRAWING TITLE: FILTR SKID 8" EBS 10K WITH PUMP AND CONTROLS
SCALE: 1:24	DRAWING NUMBER: 700301-000034
SHEET 1 OF 2	CAT NUMBER: 700301-000034
DRAWN BY: MAV	REV. NO. 0
CHECKED BY: SAL	GENERAL TOLERANCES (EXCEPT AS NOTED)
APPROVED BY: _____	ANGULAR ± 1° FRACTIONAL ± 1/8" Dec: 2 PL ± 0.05", 3 PL ± 0.010"

NO.	REVISION NOTES	DATE	BY

460V/3φ/60 Hz

L1 L2 L3

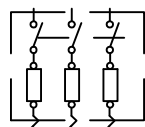

MAIN DISCONNECT AND BRANCH CIRCUIT PROTECTION PROVIDED BY OTHERS (MAXIMUM OF 90A DUAL TIME DELAY FUSE OR 90A INVERSE TIME BREAKER RECOMMENDED)

LOCKABLE NON-FUSED DISCONNECT SWITCH (RATED @ 80 AMPS)

150VA TRANSFORMER	
VOLTAGE	FUSING
575	1A
460	1A
400	1A
230	2A
208	2A

ALL FUSING TO BE LITTELFUSE CL. CC CCMR OR EQUIV.

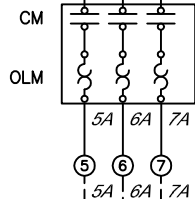
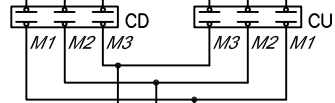
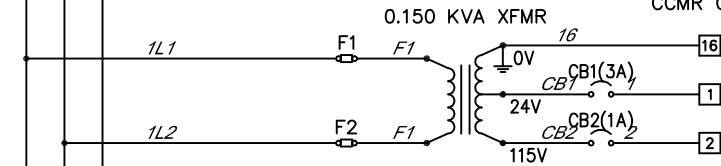

CLOSED = MOTOR ON

CLOSED = SYSTEM PUMP FAULT

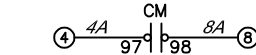

CLOSED = FLUSH IN PROGRESS

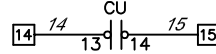

CLOSED = SYSTEM OFF/FAULT

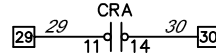

MAX. VOLTAGE: 600V
MAX. AMPERES: 5A

MAX. VOLTAGE: 600V
MAX. AMPERES: 40A

ALLEN BRADLEY
2080-LC10-12AWA

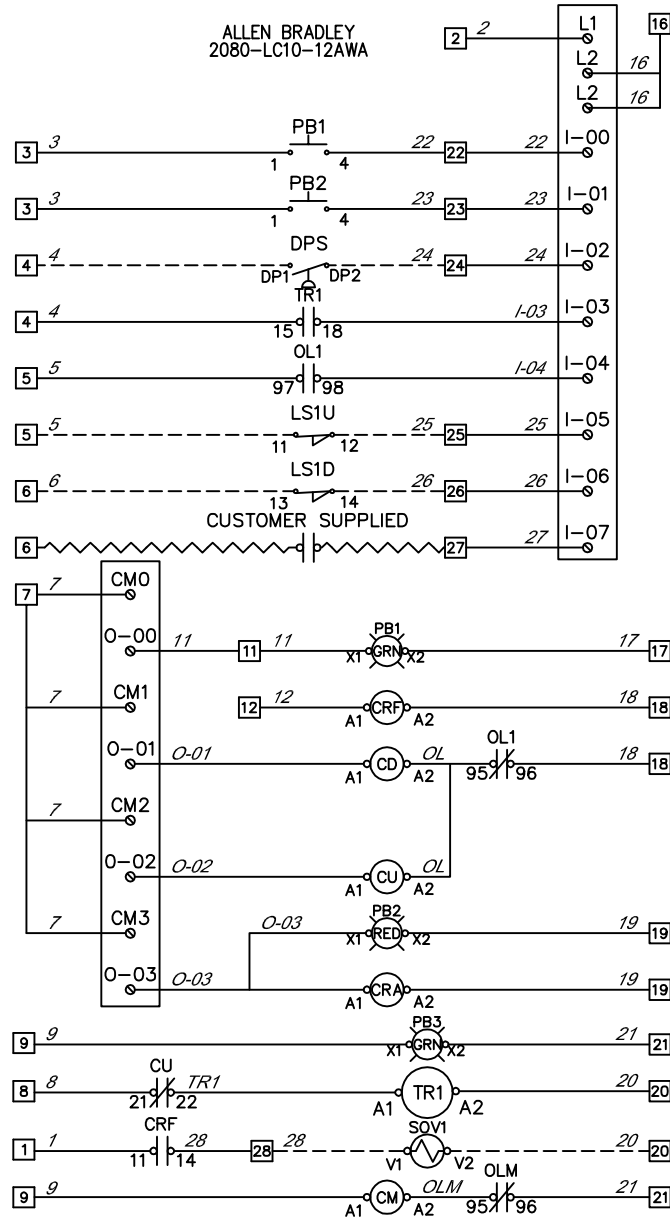

PLC POWER ON

FLUSH PUSHBUTTON

FAULT RESET PUSHBUTTON

DIFFERENTIAL PRESSURE

FLUSH INTERVAL TIMER

FAULT

UP LIMIT SWITCH

DOWN LIMIT SWITCH

REMOTE STOP

FLUSH PUSHBUTTON

FLUSH VALVE CONTROL

MOTOR DOWN

MOTOR UP

FAULT RESET PUSHBUTTON

FAULT CONTROL

POWER ON

FLUSH INTERVAL TIMER (0.05S-60HRS)

FLUSH VALVE

SYSTEM PUMP

POWER	460V/3~/60HZ
TOTAL FLA	45.33 AMPS
SCCR	5 kA RMS SYMMETRICAL, 600V MAX.
LARGEST MTR.	30 HP

STANDARD	UL 508A
SIZE	16"L x 14"W x 7"D
UL RATING	TYPE 4X
MATERIAL	POLYCARBONATE

- GROUND PER 2011 NATIONAL ELECTRICAL CODE ARTICLE 250.
- PANEL WIRING: _____
FIELD WIRING: _____
CUSTOMER'S WIRING: _____
FACTORY INSTALLED JUMPER: _____
- USE COPPER WIRE RATED 60°C MINIMUM UNLESS OTHERWISE SPECIFIED.
- DISCONNECT SWITCH TORQUE REQUIREMENTS: 35 LB IN. CONTACTOR/OVERLOAD TORQUE REQUIREMENTS: 7-10 LB IN.
- SIZE THE MAIN DISCONNECT AND BRANCH CIRCUIT PROTECTION PER 2011 NATIONAL ELECTRIC CODE ARTICLE 430.

- CONDUIT HUBS AND FITTINGS MUST HAVE THE SAME UL ENVIRONMENTAL RATING AS THE CONTROL PANEL ENCLOSURE.
- WIRE COLORS ARE AS FOLLOWS-LINE=BLACK, AC=RED, NEUTRAL=WHITE, DC+=BLUE, DC-=WHITE/BLUE, GROUND=GREEN/YELLOW, EXTERNAL SOURCE=YELLOW.
- SET MOTOR OVERLOADS ACCORDING FLA ON MOTOR DATA PLATE
- ALL MOTOR WIRING TO BE AT LEAST CU. 75° RATED.
- TB1= [5] TBA= [1] TBB= [1]



120-J TALBERT ROAD
MOORESVILLE, NC 28117 USA
(704) 662-3133 FAX (704) 662-3155

THIS DRAWING AND THE INFORMATION CONTAINED HEREIN IS THE PROPERTY OF AMIAD WATER SYSTEMS. ANY USE OR REPRODUCTION THEREOF WITHOUT THE WRITTEN PERMISSION OF AMIAD WATER SYSTEMS ENGINEERING DEPARTMENT IS STRICTLY PROHIBITED.

DRAWING DATE: 11/23/2015	DRAWING TITLE: 1F 460V/3~ SOL AMD 1-5A, 16-40A WIRING DIAGRAM
SCALE: 1" = 1"	DRAWING NUMBER: 720102-000661-ELC
SHT. 1 of 2	REV. NO. 0
DRAWN BY: RAM	CATALOG NUMBER: 720102-000661
CHKD BY: _____	GENERAL TOLERANCES (EXCEPT AS NOTED)
APP. BY: _____	ANGULAR ±1° FRACTIONAL ± 1/8" DEC: 2PL±0.05", 3PL±0.010"

NO.	DATE	NOTES	BY
GENERAL REVISIONS			

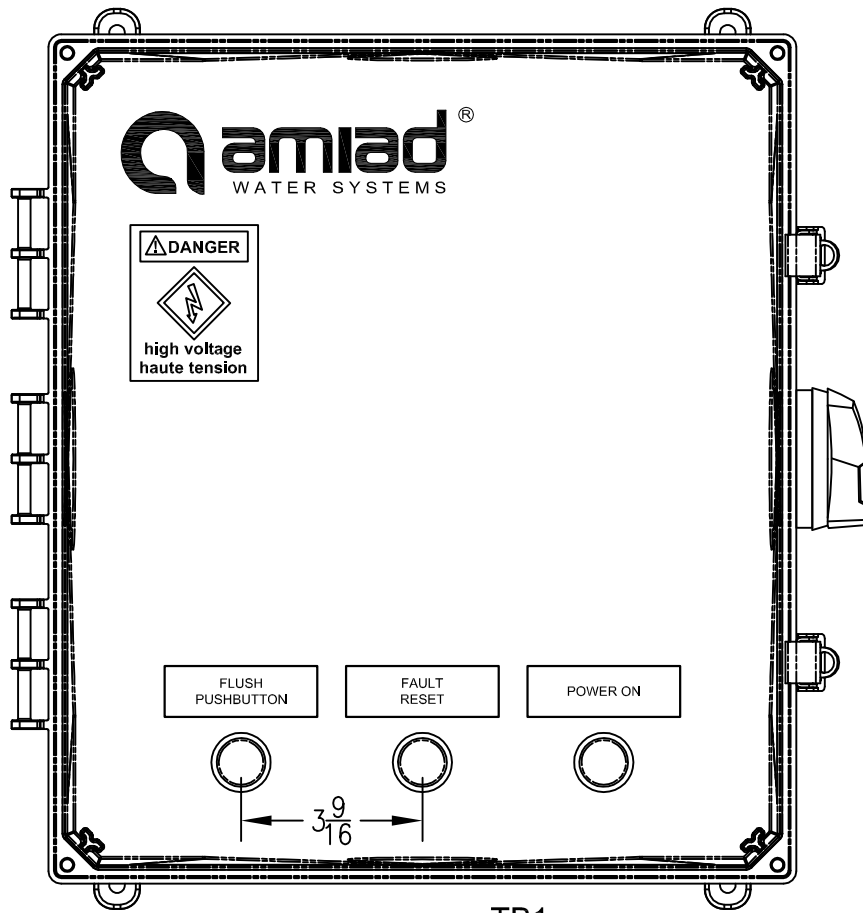

TB1

UPPER LEVEL

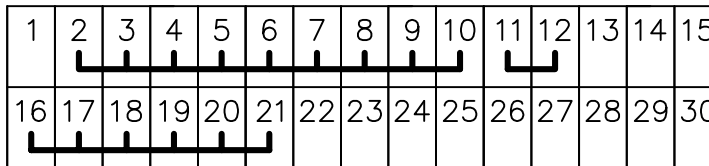

LOWER LEVEL

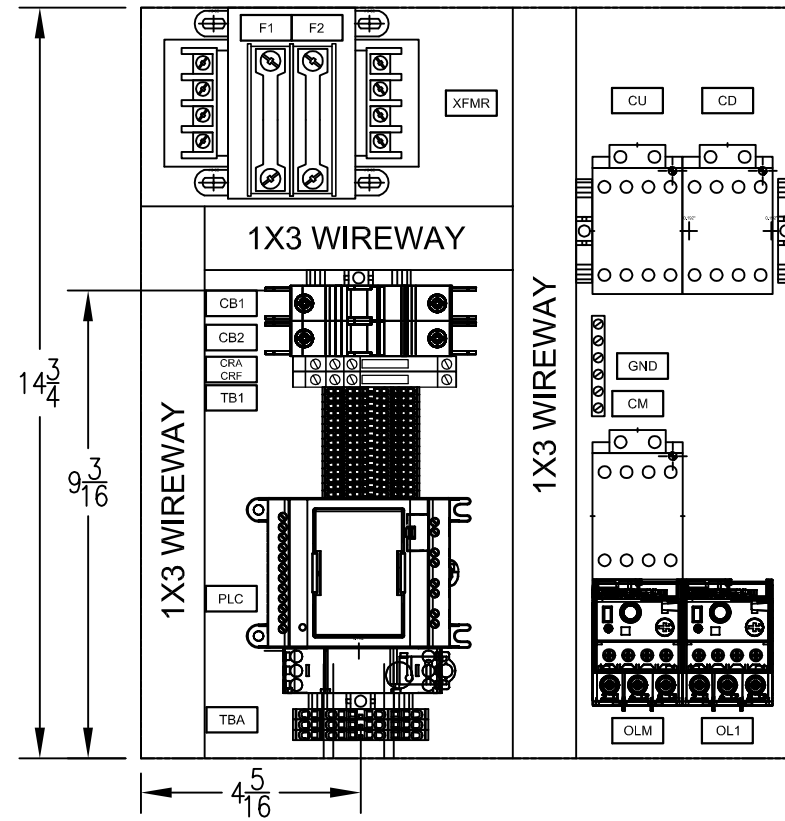

TBA

UPPER LEVEL

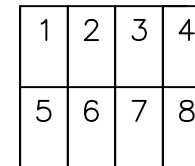

LOWER LEVEL

NOTE

1. ALL HARDWARE WILL INCLUDE ONE MECHANICAL LOCK AND A FLAT WASHER.
2. THE ONLY EXCEPTION IS IF THE MECHANICAL SCREW IS A SELF-THREADING SCREW.
3. IF BOLT/SCREW NEEDS TO GO THROUGH A THROUGH-HOLE, THE BOLT/SCREW WILL NEED A FLAT WASHER ON BOTH SIDES OF THE MATERIAL AND MECHANICAL LOCK BEFORE THE NUT.
4. ALL HARDWARE HAS TO THREAD AT LEAST TWO COMPLETE TURNS THROUGH THE NUT/THREADED HOLE
5. IF VISIBLE, NO HARDWARE WILL EXTEND PAST THREE THREADS OUT OF THE NUT/THREADED HOLE.
6. BACKPLANE AND DEAD FRONT IF REQUIRED ARE TO BE GROUNDED ACCORDING NEC 70E.
7. UNLESS OTHERWISE NOTED, ALL CONTACTORS WILL BE AB 100-C, OVERLOADS AB 193 E-1, CONTROL RELAYS AB 700-HLT, AND CIRCUIT BREAKERS AB 1489.

Amiad® WATER SYSTEMS 120-J TALBERT ROAD MOORESVILLE, NC 28117 USA (704) 662-3133 FAX (704) 662-3155

THIS DRAWING AND THE INFORMATION CONTAINED HEREIN IS THE PROPERTY OF AMIAD WATER SYSTEMS. ANY USE OR REPRODUCTION THEREOF WITHOUT THE WRITTEN PERMISSION OF AMIAD WATER SYSTEMS ENGINEERING DEPARTMENT IS STRICTLY PROHIBITED.

DRAWING DATE: 11/23/2015	DRAWING TITLE: 1F 460V/3~ SOL AMD 1-5A, 16-40A WIRING DIAGRAM	
SCALE: 1" = 4"	DRAWING NUMBER: 720102-000661-ELC	REV. NO. 0
SHT. 2 of 2	CATALOG NUMBER: 720102-000661	
DRAWN BY: RAM	GENERAL TOLERANCES (EXCEPT AS NOTED)	ANGULAR ±1° FRACTIONAL ± 1/8" DEC: 2PL±0.05", 3PL±0.010"
NO. DATE	NOTES	BY
GENERAL REVISIONS		
APP. BY: ---	CHKD BY: ---	